

DFW37C-1-LID

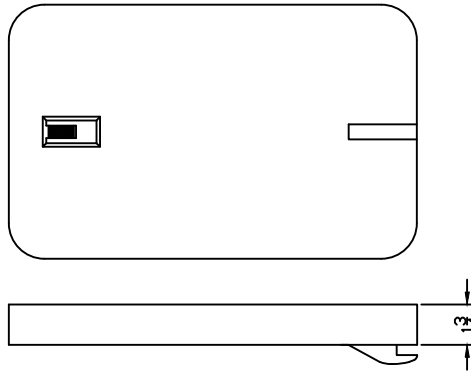

LID KEY	
1	BLACK COLOR

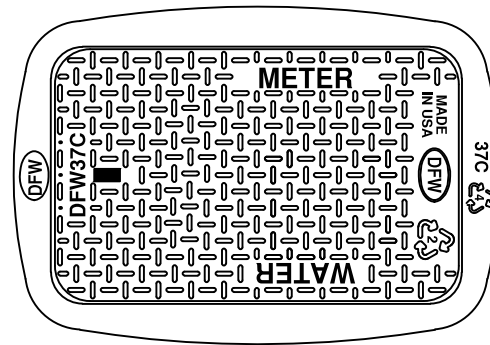
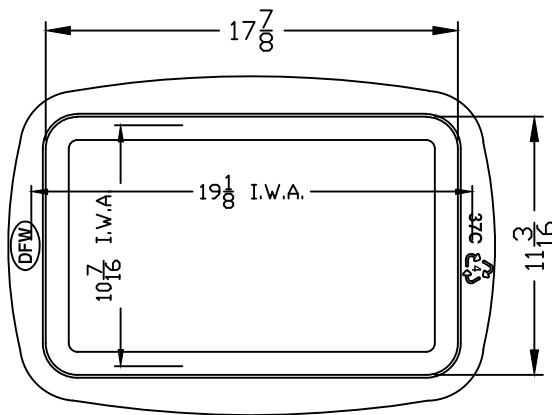

DFW37C-12-1

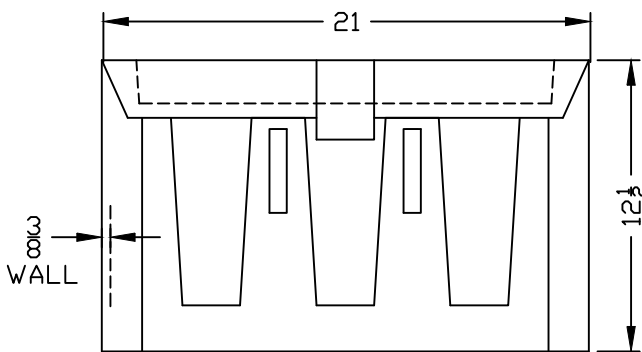

DFW37C-12-BODY

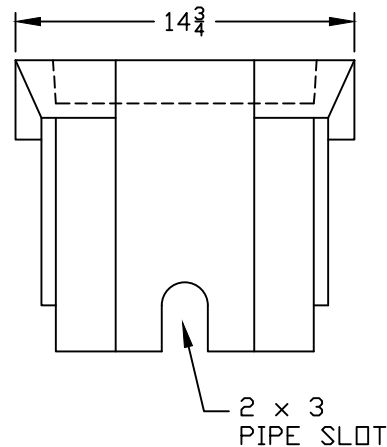

NOTES

- 1) DIM'S ± 1/8" U.N.O.
- 2) LID MATERIAL: HDPE
- 3) BODY MATERIAL: LLDPE
- 4) WALL THICKNESS: 3/8" ± 5%
- 5) I.W.A. = INSIDE WORK AREA

DFW PLASTICS, INC. ENGAGES IN ONGOING RESEARCH AND DEVELOPMENT TO IMPROVE AND ENHANCE ITS PRODUCTS. THEREFORE, DFW PLASTICS, INC. RESERVES THE RIGHT TO CHANGE PRODUCT OR SYSTEM SPECIFICATIONS WITHOUT NOTICE.



DFW PLASTICS, INC.
PO BOX 648
BEDFORD, TEXAS 76095
(817) 439-3600
(817) 439-3700 (f)
www.dfwplasticsinc.com

DFW37C-12-1

CREATED: 04/28/2015

UPDATED: 04/28/2015

ACCEPTED: JMc

DRAWN BY: RMc

PLOT SCALE: 1:8